









Smart Membrane Solutions





2021 Parts List

3.8" RO Membrane Plant Accessories.....	2
6.3" UF Membrane Plant Accessories.....	3
8.0" UF Membrane Accessories.....	4
8.0" RO Membrane Accessories.....	5
8.0" RO Membrane Housing Layout Options.....	6
Permeate Connection Hoses.....	7
Permeate Connection Recommended Installation.....	8
Seal Selection.....	9
Removal Tools.....	9
Ordering Information.....	10





3.8" RO Membrane Plant Accessories

Part Number	Description
	38-L-0830-IC-PS 3.8" Gold polysulfone ATD with lip seal profile to suit 0.830" permeate tube
	38-L-0830-IC-ST06 3.8" Stainless Steel ATD with lip seal profile to suit 0.830" permeate tube. 6mm thick SS
	S-L-BEP Small Blank End Plug with lip seal profile to suit 0.830" Permeate tube
	S-L-BEP-ST Small Stainless Steel Blank End Plug with lip seal profile to suit 0.830" permeate tubes.
	S-L-EPDM Small Lip Seal BLACK EPDM to suit 0.830" permeate tube
	S-L-VITON Small Lip Seal ORANGE VITON to suit 0.830" permeate tube
	Permeate hoses Permeate Connection Hoses come in a range of sizes, see table below for sizes







6.3" UF Membrane Plant Accessories

Part Number	Description
	<p>63-L-1138-IC-PS</p> <p>6.3" Gold polysulfone ATD with lip seal profile to suit 1.138" Permeate tube</p>
	<p>63-L-1138-IC-ST08</p> <p>6.3" Stainless Steel ATD with lip seal profile to suit 1.138" permeate tube. 8mm thick SS</p>
	<p>L-L-BEP</p> <p>Large Blank End Plug with lip seal profile to suit 1.125" and 1.138" permeate tubes</p>
	<p>L-L-BEP-ST</p> <p>Large Stainless Steel Blank End Plug with lip seal profile to suit 1.125" and 1.138" permeate tubes.</p>
	<p>Permeate hoses</p> <p>Permeate Connection Hoses come in a range of sizes, see table below for sizes</p>

8.0" UF Membrane Accessories

	Part Number	Description
	80-L-1138-IC-ST10	8.0" Stainless Steel ATD with lip seal profile to suit 1.138" permeate tube. 10mm thick SS Designed for 8.0" UF
	L-L-BEP	Large Blank End Plug with lip seal profile to suit 1.125" and 1.138" permeate tubes
	L-L-BEP-ST	Large Stainless Steel Blank End Plug with lip seal profile to suit 1.125" and 1.138" permeate tubes.
	L-L-VITON	Large Lip Seal ORANGE VITON to suit 1.138" permeate tube
	Permeate hoses	Permeate Connection Hoses come in a range of sizes, see table below for sizes

8.0" RO Membrane Accessories

	Part Number	Description
	80-L-1125-IC-PS	8.0" Gold polysulfone ATD with lip seal profile to suit 1.125" Permeate tube
	80-L-1125-IC-ST10	8.0" Stainless Steel ATD with lip seal profile to suit 1.125" permeate tube. 10mm thick SS Designed for 8.0" RO
	L-L-BEP	Large Blank End Plug with lip seal profile to suit 1.125" and 1.138" permeate tubes
	L-L-BEP-ST	Large Stainless Steel Blank End Plug with lip seal profile to suit 1.125" and 1.138" permeate tubes.
	L-L-EPDM	Large Lip Seal BLACK EPDM to suit 1.125" permeate tube
	Permeate hoses	Permeate Connection Hoses come in a range of sizes, see table below for sizes

8.0" RO Membrane Housing Layout Options

Polysulfone Layout Option

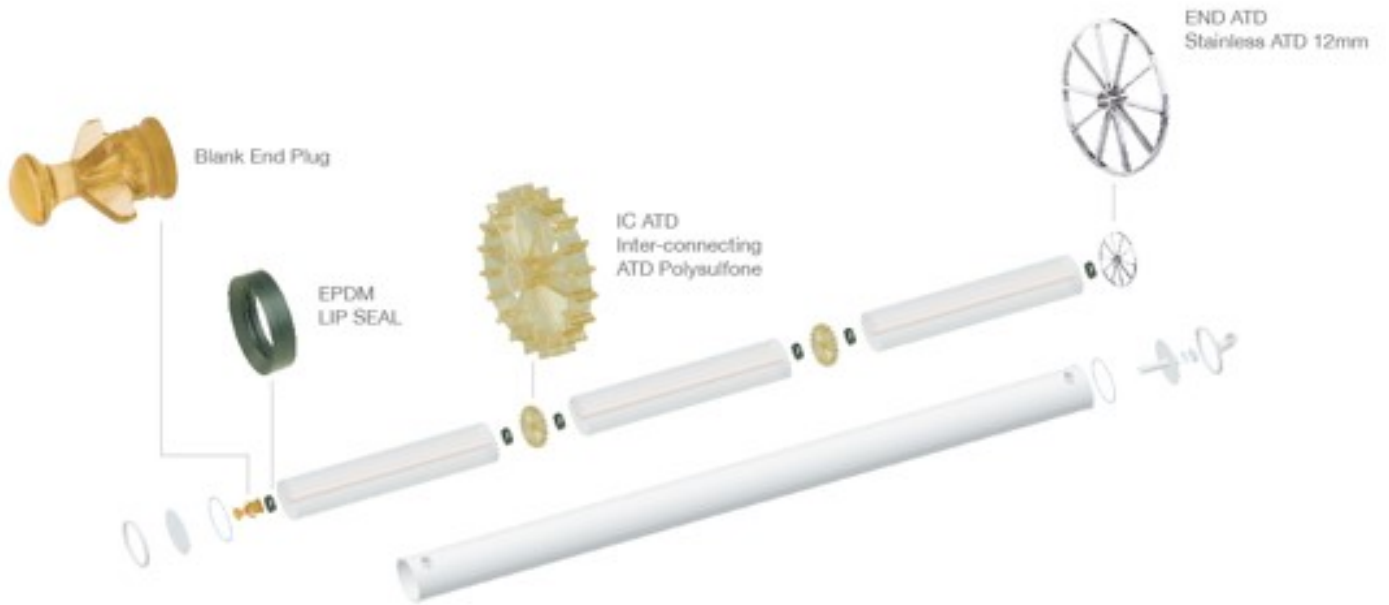

Stainless Layout Option



Permeate Connection Hoses

Temperature range: -10°C + 60°C, Max Working Pressure 6 Bar, Max Bend Radius 130°

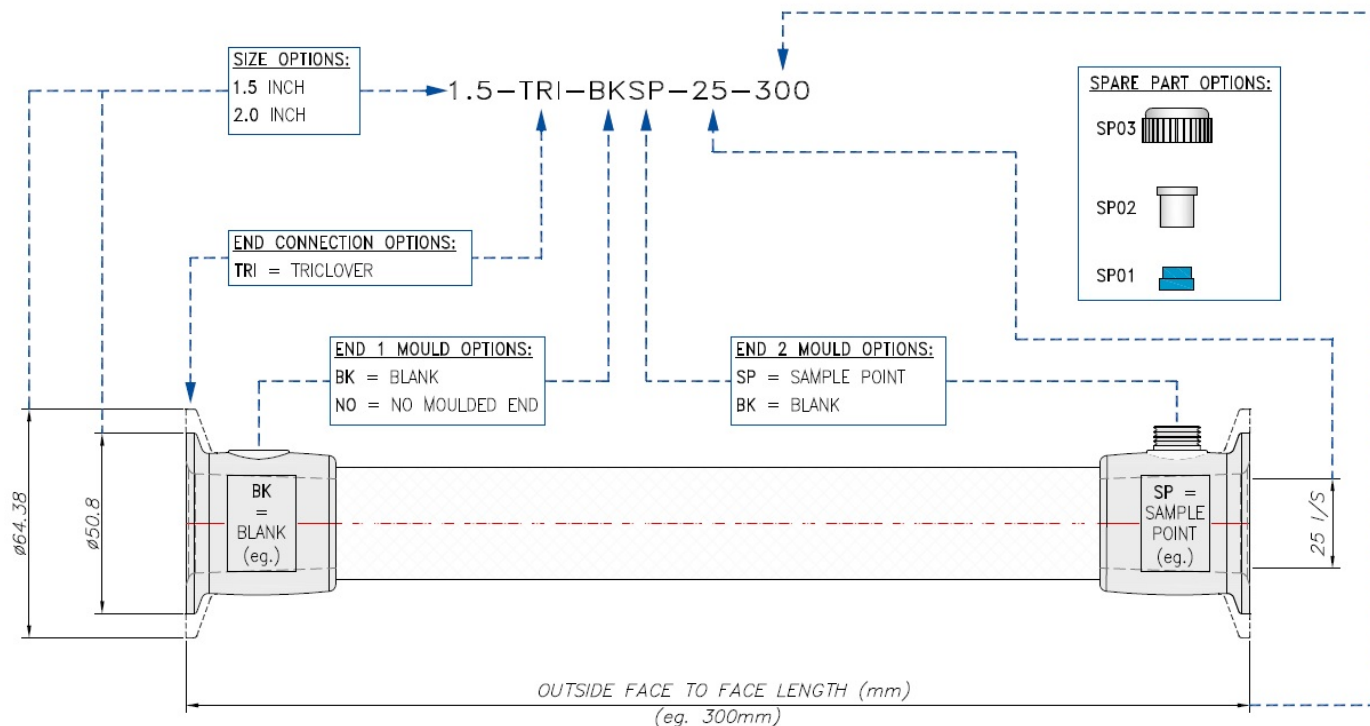

Product Description	Code
Sample Point	
1.5" Tri-clover with Sample Point 25mm Dia hose 300mm long	1.5-TRI-BKSP-25-300
1.5" Tri-clover with Sample Point 25mm Dia hose 450mm long	1.5-TRI-BKSP-25-450
2.0" Tri-clover with Sample Point 25mm Dia hose 300mm long	2.0-TRI-BKSP-25-300
2.0" Tri-clover with Sample Point 25mm Dia hose 450mm long	2.0-TRI-BKSP-25-450
No Sample Point	
1.5" Tri-clover with no Sample Point 25mm Dia hose 300mm long	1.5-TRI-BK BK-25-300
1.5" Tri-clover with no Sample Point 25mm Dia hose 450mm long	1.5-TRI-BK BK-25-450
2.0" Tri-clover with no Sample Point 25mm Dia hose 300mm long	2.0-TRI-BK BK-25-300
2.0" Tri-clover with no Sample Point 25mm Dia hose 450mm long	2.0-TRI-BK BK-25-450

Permeate Connection Recommended Installation

Hose Type				
Hose No.	Angle	Total Length	Ferrule Size	Radius
A	45°	300mm	ø38/51 O/D	275mm
B	90°	300mm	ø38/51 O/D	138mm
C	45°	450mm	ø38/51 O/D	465mm
D	90°	450mm	ø38/51 O/D	233mm

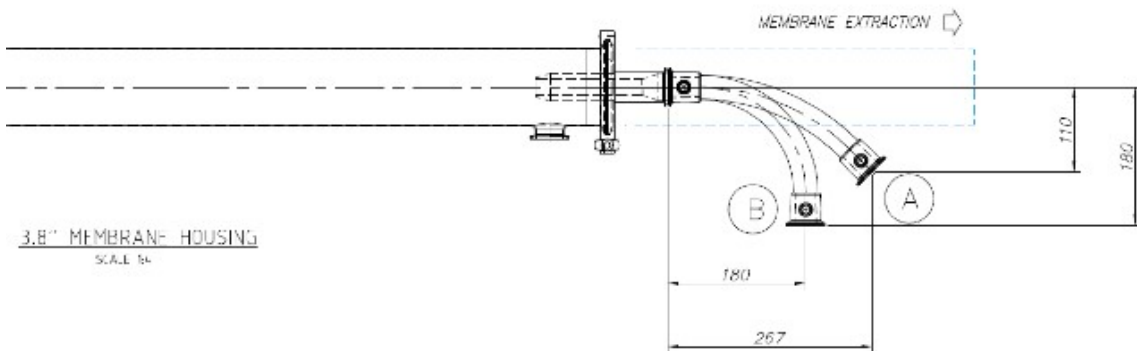
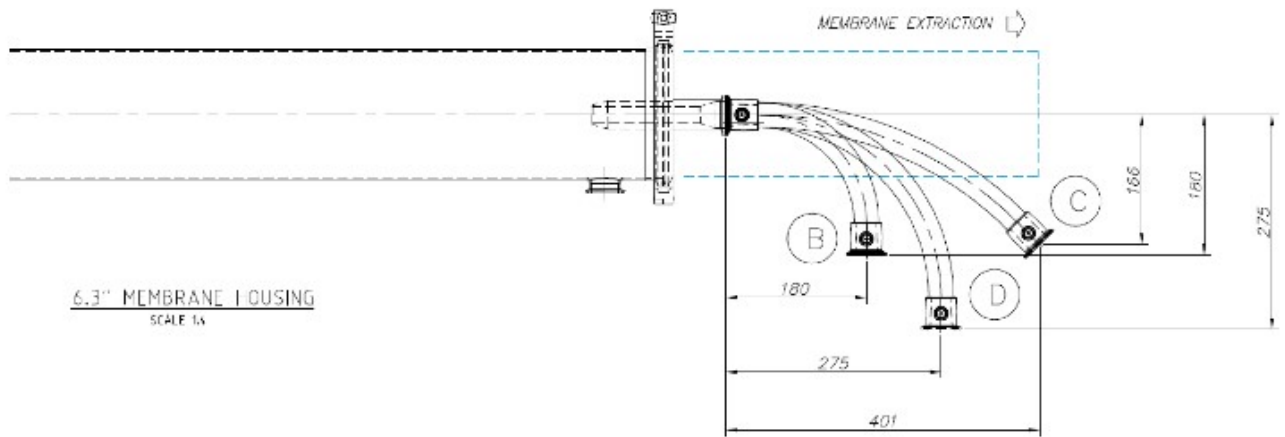
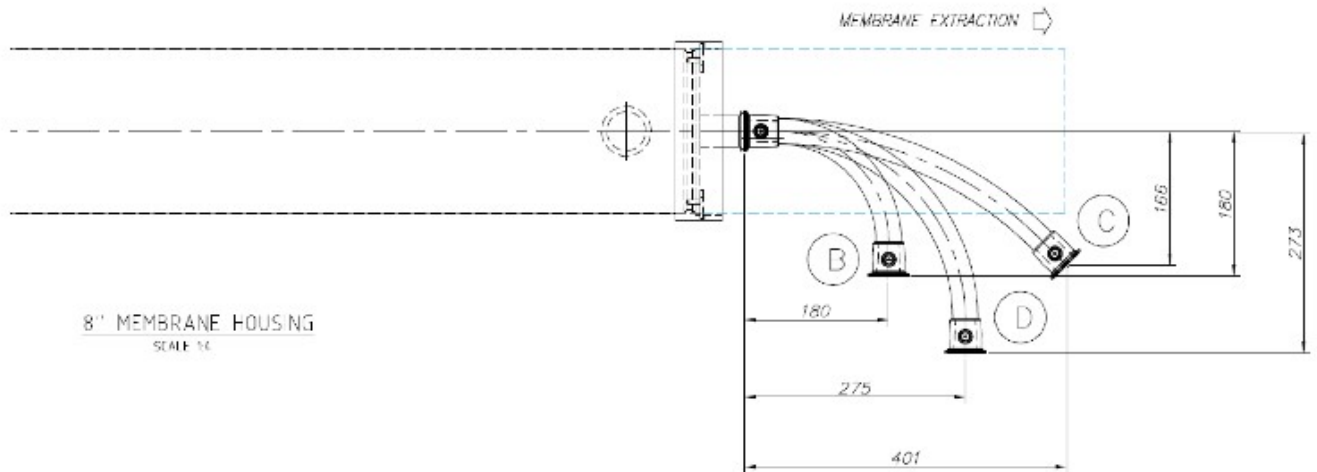

Seal Selection

EPDM – perfect for non chlorinated systems, specifically RO and NF applications VITON- highly recommended for chlorinated environments, specifically UF applications.

Removal Tools

	Part Number	Description
	MTK	<p>Complete Tool Kit</p> <ul style="list-style-type: none">• Housing End Cap Removal Tools• Removal of Membranes from the Housing<ul style="list-style-type: none">• Membrane Push Rod Tool• Membrane Ejector Block Pigging Tools• Removal of ATD's and Blank End Plugs from the Membranes
	MEK-SPATULA	ATD Removal Spatula Tool
	BEPREMOVAL	Blank End Plug Removal Tool

Ordering Information

Smart Membrane Solutions,

1. This Smart Membrane Solutions price list supersedes all other price lists.
2. Prices are Ex-store, NZ.
3. Prices are subject to change without notice.
4. All prices in New Zealand Dollars (\$NZ).

Orders,

A company Purchase Order must be received before product is dispatched.

Please send Purchase Order by email to: orders@smartmembranesolutions.co.nz

For all Smart Membrane Solutions customer service and ordering please make sure that your records list the following information:

Smart Membrane Solutions
PO Box 148
Rolleston 7643

Telephone +64 3 741 1808

Visit our web site at www.smartmembranesolutions.co.nz for detailed product information and specifications.